

# ViewSonic®

## VFD823 Digital Photo Frame

- User Guide
- Guide de l'utilisateur
- Guía del usuario

IMPORTANT: Please read this User Guide to obtain important information on installing and using your product in a safe manner, as well as registering your product for future service. Warranty information contained in this User Guide will describe your limited coverage from ViewSonic Corporation, which is also found on our web site at <http://www.viewsonic.com> in English, or in specific languages using the Regional selection box in the upper right corner of our website. "Antes de operar su equipo lea cuidadosamente las instrucciones en este manual"



Model No. : VS13787

# Compliance Information

## FCC Statement

This device complies with part 15 of FCC Rules. Operation is subject to the following two conditions: (1) this device may not cause harmful interference, and (2) this device must accept any interference received, including interference that may cause undesired operation.

This equipment has been tested and found to comply with the limits for a Class B digital device, pursuant to part 15 of the FCC Rules. These limits are designed to provide reasonable protection against harmful interference in a residential installation. This equipment generates, uses, and can radiate radio frequency energy, and if not installed and used in accordance with the instructions, may cause harmful interference to radio communications. However, there is no guarantee that interference will not occur in a particular installation. If this equipment does cause harmful interference to radio or television reception, which can be determined by turning the equipment off and on, the user is encouraged to try to correct the interference by one or more of the following measures:

- Reorient or relocate the receiving antenna.
- Increase the separation between the equipment and receiver.
- Connect the equipment into an outlet on a circuit different from that to which the receiver is connected.
- Consult the dealer or an experienced radio/TV technician for help.

**Warning:** You are cautioned that changes or modifications not expressly approved by the party responsible for compliance could void your authority to operate the equipment.

## For Canada

- This Class B digital apparatus complies with Canadian ICES-003.
- Cet appareil numérique de la classe B est conforme à la norme NMB-003 du Canada.

# Declaration of RoHS Compliance

This product has been designed and manufactured in compliance with Directive 2002/95/EC of the European Parliament and the Council on restriction of the use of certain hazardous substances in electrical and electronic equipment (RoHS Directive) and is deemed to comply with the maximum concentration values issued by the European Technical Adaptation Committee (TAC) as shown below:

<b>Substance</b>	<b>Proposed Maximum Concentration</b>	<b>Actual Concentration</b>
Lead (Pb)	0.1%	< 0.1%
Mercury (Hg)	0.1%	< 0.1%
Cadmium (Cd)	0.01%	< 0.01%
Hexavalent Chromium (Cr <sup>6+</sup> )	0.1%	< 0.1%
Polybrominated biphenyls (PBB)	0.1%	< 0.1%
Polybrominated diphenyl ethers (PBDE)	0.1%	< 0.1%

Certain components of products as stated above are exempted under the Annex of the RoHS Directives as noted below:

Examples of exempted components are:

1. Mercury in compact fluorescent lamps not exceeding 5 mg per lamp and in other lamps not specifically mentioned in the Annex of RoHS Directive.
2. Lead in glass of cathode ray tubes, electronic components, fluorescent tubes, and electronic ceramic parts (e.g. piezoelectronic devices).
3. Lead in high temperature type solders (i.e. lead-based alloys containing 85% by weight or more lead).
4. Lead as an alloying element in steel containing up to 0.35% lead by weight, aluminium containing up to 0.4% lead by weight and as a copper alloy containing up to 4% lead by weight.

# Copyright Information

Copyright © ViewSonic® Corporation, 2011. All rights reserved.

ViewSonic, the three birds logo, OnView, ViewMatch, and ViewMeter are registered trademarks of ViewSonic Corporation.

Disclaimer: ViewSonic Corporation shall not be liable for technical or editorial errors or omissions contained herein; nor for incidental or consequential damages resulting from furnishing this material, or the performance or use of this product.

In the interest of continuing product improvement, ViewSonic Corporation reserves the right to change product specifications without notice. Information in this document may change without notice.

No part of this document may be copied, reproduced, or transmitted by any means, for any purpose without prior written permission from ViewSonic Corporation.

## For Your Records

<b>Product Name:</b>	VFD823 ViewSonic Digital Photo Frame
<b>Model Number:</b>	VS13787
<b>Document Number:</b>	VFD823_UG_ENG Rev. 1c 02-23-11
<b>Serial Number:</b>	_____
<b>Purchase Date:</b>	_____

### Product disposal at end of product life

ViewSonic respects the environment and is committed to working and living green. Thank you for being part of Smarter, Greener Computing. Please visit ViewSonic website to learn more.

USA & Canada: <http://www.viewsonic.com/company/green/recycle-program/>

Europe: <http://www.viewsoniceurope.com/uk/support/recycling-information/>

Taiwan: <http://recycle.epa.gov.tw/recycle/index2.aspx>

# Important Safety Information

Always follow the basic safety precautions below when using your Digital Photo Frame. This will reduce the risk of fire, electric shock, and injury.

**Warning:** To reduce the risk of fire or shock hazard, do not expose this product to rain or moisture.

**Warning:** To prevent the risk, do not remove the cover, there are no spare parts inside, refer all product services to professional personnel.

- Digital Photo frame is for indoor use only.
- Unplug Digital Photo frame before performing care and maintenance.
- Do not block the ventilation holes on the back of Digital Photo Frame at any time.
- Keep your Multimedia Digital Photo Frame out of direct sunlight and heat source.
- Protect the power cord. Route power cords appropriately to avoid trip over by someone else or pinched by items placed on or against it. Pay particular attention to the point where the cord attaches to Digital Photo Frame.
- Only use the AC adapter included with the Digital Photo Frame. Using any other power adapter will void your warranty.
- Unplug the power cord from the outlet when the unit is not in use.

## Cleaning LCD Screen

Touch the screen gently. The screen is made of glass which can be scratched or damaged.

To clean fingerprints or dust from the LCD screen, we recommend using a soft / nonabrasive cloth such as a camera lens cloth to clean the LCD screen.

If you use a commercial LCD cleaning kit, do not apply the cleaning liquid directly to the LCD screen. Clean the LCD screen with a cleaning cloth moistened with the liquid.

## Package Content

- Digital Photo Frame
- AC power adapter (5V, 1A)
- User Guide
- Quick Start Guide
- Stand

# Table of Contents

1.Precautions .....	2
2.Product Information .....	3
2.1 Features .....	3
2.2 Specifications .....	3
2.3 Accessories .....	3
2.4 Navigation Buttons .....	4
2.5 Input Connections .....	5
3.Getting Started .....	6
3.1 Stand .....	6
4.Operating Instructions .....	7
4.1 Turn on/off the Digital Photo Frame .....	7
4.2 OSD Navigation .....	7
4.3 Viewing Photos .....	8
4.4 View Calendar .....	9
4.5 Settings .....	10
5.Troubleshooting .....	11

# 1. Precautions

## Warnings

Please read this manual carefully before operating and save it for future reference.

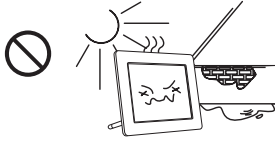

Avoid exposing this device to water, moisture or high temperature. Do not place it near swimming pool, bathtub or sink where it may come in contact with water.



Clean only with a dry soft cloth; do not use any chemical liquid for cleaning.

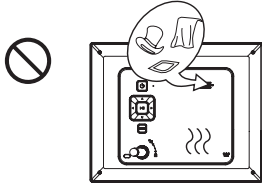

To ensure reliable operation of the device and to protect it from overheating, do not block any ventilation openings.

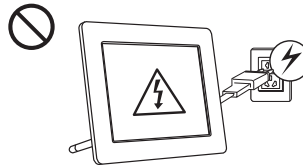

Only use accessories specified by the manufacturer.

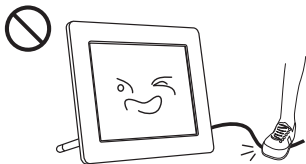

Do not step on the power cable, plug or adapter to avoid electrical shock.



Do not attempt to service this device yourself. Opening or removing covers may expose you to electrical shock or other hazards. Refer all services to a qualified service personnel.

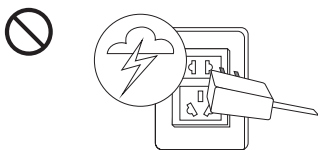

Please unplug this device during the thunderstorm or not in use for a long period.



Do not apply force on the LCD screen during transport or usage. Avoid sharp objects.

## **2.Product Information**

### **2.1 Features**

- High quality 8 inch LCD: 800x600 high resolution.
- Slim and fashionable design, suitable for gifts and home decoration.
- High-speed picture decoding technology in JPG format with rotation and zooming supported.
- Slideshow with multiple transition effects.
- Calendar and Clock functions.
- User-friendly navigation buttons.
- Three-in-one (SD/SDHC/MMC) and USB flash drive supported.

### **2.2 Specifications**

LCD Screen	Panel size / Aspect ratio	8-inch 4:3		
	Effective viewing area	162.0(W)x121.5(H) mm (6.4"W x 4.8"H)		
	Resolution	800(W)x600(H) pixels		
Photo File	Image formats supported	JPG, JPEG (baseline coding)		
	Max. image resolution	30 million pixels		
Calendar		Clock, Calendar		
Memory Medium	Memory Card supported	MMC, SD, SDHC (max. 16GB)		
	USB	USB flash drive		
	File system	FAT, FAT32		
Electrical Specifications	Power input	5VDC, 1.0A		
	Power consumption	≤5W		
	Power adapter	Input	AC 100-240V, 50/60Hz	
		Output	DC5V, 1.0A	
Dimensions	Dimensions	217x176x24 mm (8.5"W x 6.9"H x 0.9"D)		
	Weight	Approx. 415g (0.9 lbs)		
	Operating mode	Buttons on the panel		
Environmental Requirements	Operating temperature	0°C~40°C (32°F~104°F)		
	Storage temperature	-20°C~60°C (-4°F~140°F)		



## 2.3 Accessories

Digital Photo Frame -----	1 piece
Power adapter -----	1 piece
User's manual -----	1 piece
Quick start guide -----	1 piece
Stand -----	1 piece

## 2.4 Navigation Buttons

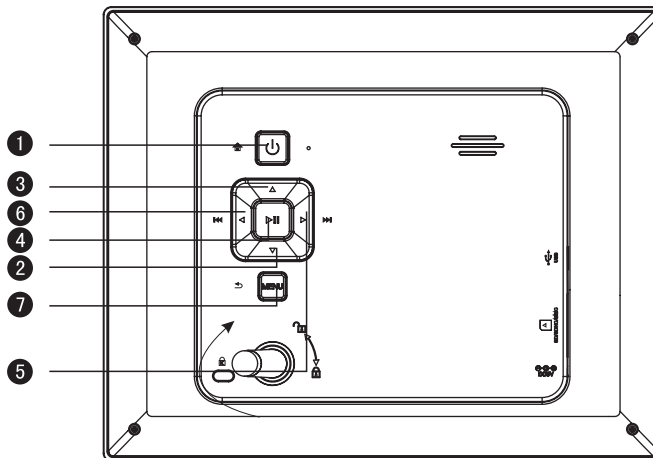

- ❶ Power:** a. Press briefly to turn on the device when the power is off;  
b. Press & hold to turn off the device when the power is on;  
c. Press briefly to turn to the Main Menu when the power is on.
- ❷ DOWN:** Down.
- ❸ UP:** Up.
- ❹ PLAY:** a. Confirm/Enter; b. Press & hold for 3s to pop up the shortcut menu; c. Play/ pause.
- ❺ LEFT:** a. Left; b. Backward.
- ❻ RIGHT:** a. Right; b. Forward.
- ❼ RETURN:** Exit.

## 2.5 Input Connections

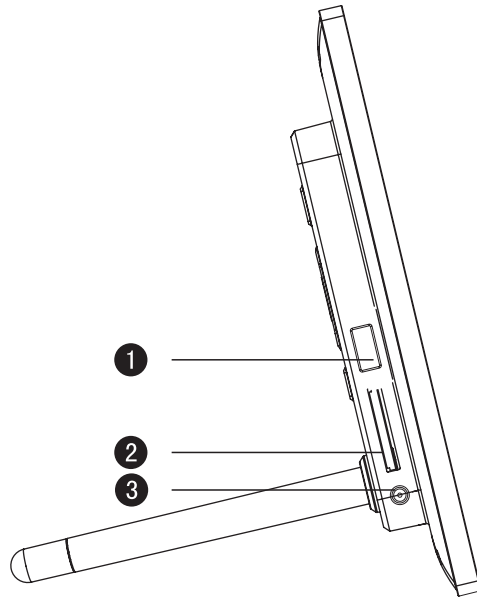

- ❶ **USB** : connect to USB flash drive.
- ❷ **SD/SDHC/MMC card slot**.
- ❸ **DC-IN**: power input 5V DC 1.0A

## 3. Getting Started

### 3.1 Stand

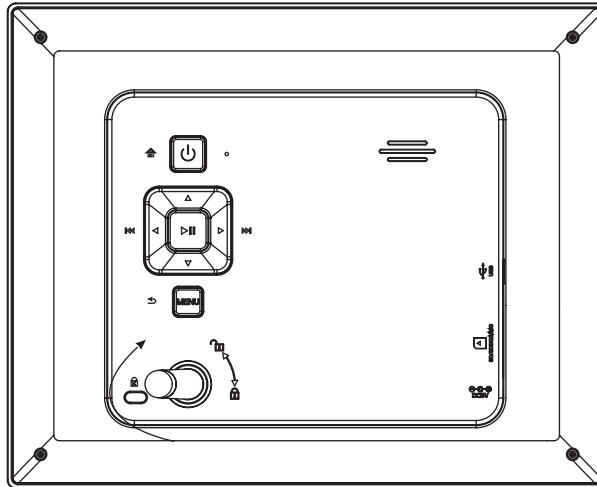

**Attaching the stand:** screw in the stand clockwise until it is secure.

**Removing the stand:** unscrew the stand counter-clockwise until it is detached.

## 4. Operating Instructions

### 4.1 Turn on/off the Digital Photo Frame

#### ■ Power on

Press briefly [  ] on the device, the device will be turned on.

#### ■ Power off

Press & hold [  ] on the device, the device will be turned off.

### 4.2 OSD Navigation

#### ■ Main Menu

The Main Menu is shown below. Press the Left and Right buttons to select an icon, and press Enter [  ].

#### ■ Return to the Main Menu

Press briefly [  ], the device will return to the Main Menu.

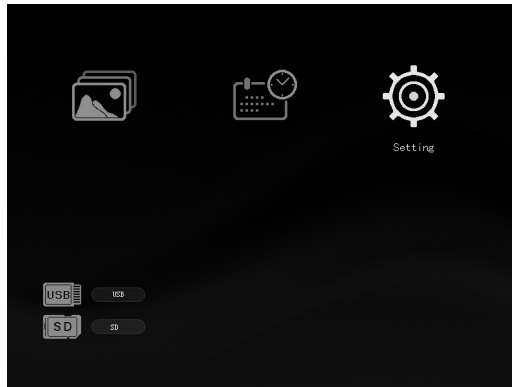

## 4.3 Viewing Photos

### ■ Slideshow

Insert an SD/SDHC/MMC or USB memory source device into an appropriate memory slot, the photo frame will start slideshow automatically.

To exit slideshow, press the RETURN button.

To start slideshow at a particular photo, press either the LEFT or RIGHT button and then press PLAY.



### ■ Slideshow setup

Step 1: Press & hold [▶||] for the slideshow sub-menu.

Step 2: Press [◀▶] to select an option.

Step 3: Press [▶||] to confirm and press [⏪] to exit the sub-menu.

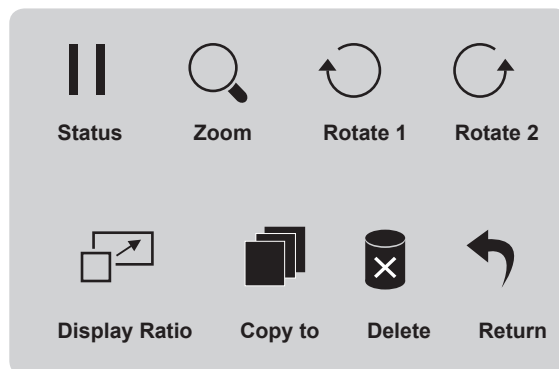

**Status:** Pause and Play.

**Zoom:** zoom in an image.

**Rotate 1:** rotate an image clockwise.

**Rotate 2:** rotate an image counter-clockwise.

**Display Ratio:** select from Auto, Original, Crop and Stretch.

**Copy to:** Copy photos to internal photo frame memory. It is recommended that each image is no larger than 50KB.

**Delete:** delete the selected photo.

**Return:** exit.

## 4.4 View Calendar

Step 1: Use [ ◀ ▶ ] to select “Calendar” icon on the Main Menu.

Step 2: Press [ ▶|▶ ] to display a calendar.

Step 3: Use the UP button to view the previous month and use the DOWN button to view next month.



## 4.5 Settings

Step 1: Use [ ◀ ▶ ] to select "Setting" icon on the Main Menu.

Step 2: Press [ ▶|▶ ] to enter the Setup Menu. The Photo Setup, Calendar Setup and System Setup setting is shown below.

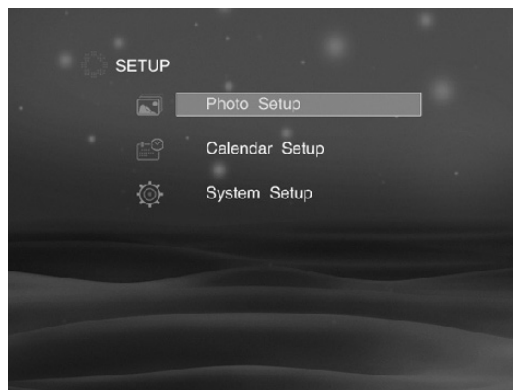

**Photo Setup:** Select “Photo Setup” and press ENTER.

**Display Ratio:** Use [ ◀ ▶ ] to select from Crop to Fill, Full Screen and Fit to Screen.

**Slideshow time:** Use [ ◀ ▶ ] to select from 5sec, 15sec, 30sec, 60sec, 5min and 15min.

**Transition effect:** Use [ ◀ ▶ ] to select from 11 transition effects; mosaic, cross, rectangle, spiral, none, random, block, split, reveal, blind, tiny lines.

**Mode:** Use [ ◀ ▶ ] to switch among Random, Order.

**Calendar Setup:** Select “Calendar Setup” and press ENTER.

**Set Date:** Press [ ▼ ▲ ] to go backward and forward among the options, and [ ◀ ▶ ] to change the value.

**Clock Mode:** Use [ ◀ ▶ ] to select between 12Hr and 24Hr.

**Set Time:** Use [ ▼ ▲ ] to select an option, and [ ◀ ▶ ] to change the value.

**System Setup:** Select “System Setup” and press ENTER.

**Language:** Use [ ◀ ▶ ] to select the on-screen language.

**Backlight:** Use [ ◀ ▶ ] to adjust the brightness level.

**Power On:** Use [ ◀ ▶ ] to enable auto power on.

**Auto Boot Time:** Set the timer for the photo frame to turn on automatically.

Use [ ▼ ▲ ] to select an option, and [ ◀ ▶ ] to change the value.

**Power Off:** Use [ ◀ ▶ ] to enable auto power off.

**Auto Off Time:** Set the timer for the photo frame to turn off automatically.

Use [ ▼ ▲ ] to select an option, and [ ◀ ▶ ] to change the value.

**Auto-Power Frequency:** Use [ ◀ ▶ ] to set how often you want the photo frame to use the auto power on feature.

**USB Options:** Udisk (for VFD823 only).

**Default:** Press ENTER to restore to factory settings. Select “Yes” (dark blue) and press ENTER again to confirm.

**Version:** Press ENTER to display the current firmware version.

**System Upgrade:** For firmware upgrade.

## 5.Troubleshooting

<b>Problem &amp; Solution</b>	
Can not power on, and nothing happens even if connected to an outlet	Check whether the AC power adapter rating is correct, and it is securely plugged to an electrical outlet.
The screen is off	Check whether the screen brightness is set to a low level in the Setup menu.
Screen freeze and does not respond to control anymore	Unplug&replug the photo frame.
Some images are not displayed	The image file is not supported by this device. Only 800x600 or lower resolution images in JPG format (baseline coding) are supported.
Cannot read USB Flash Drive	Check whether a USB flash drive is inserted properly. The Max. Capacity of USB flash drive is 16G.
Cannot read SD/SDHC card	Check whether SD/SDHC card is inserted properly. The notch should be facing down. Do not force the memory card in.The Max. Capacity of SD/SDHC card is 16GB.
No files are displayed on the screen	File allocation table is damaged. Reboot the device.
Exit playing and went back to the Main Menu automatically	Restart playing. (Note: This device has a self protection function against sudden system abnormality.)



# Customer Support

For technical support or product service, see the table below or contact your reseller.

**Note :** You will need the product serial number.

Country/ Region	Web Site	T=Telephone F=Fax	E-mail
Australia/New Zealand	www.viewsonic.com.au	AUS=1800 880 818 NZ=0800 008 822	service@au.viewsonic.com
Canada	www.viewsonic.com	T (Toll-Free)= 1-866-463-4775 T (Toll)= 1-424-233-2533 F= 1-909-468-3757	service.ca@viewsonic.com
Europe	www.viewsoniceurope.com	www.viewsoniceurope.com/uk/support/call-desk/	
Hong Kong	www.hk.viewsonic.com	T= 852 3102 2900	service@hk.viewsonic.com
India	www.in.viewsonic.com	T= 1800 11 9999	service@in.viewsonic.com
Ireland (Eire)	www.viewsoniceurope.com/ uk/	www.viewsoniceurope.com/ uk/support/call-desk/	service_ie@viewsoniceurope.com
Korea	www.kr.viewsonic.com	T= 080 333 2131	service@kr.viewsonic.com
Latin America (Argentina)	www.viewsonic.com/la/	T= 0800-4441185	soporte@viewsonic.com
Latin America (Chile)	www.viewsonic.com/la/	T=1230-020-7975	soporte@viewsonic.com
Latin America (Columbia)	www.viewsonic.com/la/	T= 01800-9-157235	soporte@viewsonic.com
Latin America (Mexico)	www.viewsonic.com/la/	T= 001-8882328722	soporte@viewsonic.com
Renta y Datos, 29 SUR 721, COL. LA PAZ, 72160 PUEBLA, PUE. Tel: 01.222.891.55.77 CON 10 LINEAS Electroser, Av Reforma No. 403Gx39 y 41, 97000 Merida, Yucatan. Tel: 01.999.925.19.16 Other places please refer to <a href="http://www.viewsonic.com/la/soporte/index.htm#Mexico">http://www.viewsonic.com/la/soporte/index.htm#Mexico</a>			
Latin America (Peru)	www.viewsonic.com/la/	T= 0800-54565	soporte@viewsonic.com
Macau	www.hk.viewsonic.com	T= 853 2870 0303	service@hk.viewsonic.com
Middle East	ap.viewsonic.com/me/	Contact your reseller	service@ap.viewsonic.com
Puerto Rico & Virgin Islands	www.viewsonic.com	T= 1-800-688-6688 (English) T= 1-866-379-1304 (Spanish) F= 1-909-468-3757	service.us@viewsonic.com soporte@viewsonic.com
Singapore/ Malaysia/ Thailand	www.viewsonic.com.sg	T= 65 6461 6044	service@sg.viewsonic.com
South Africa	ap.viewsonic.com/za/	Contact your reseller	service@ap.viewsonic.com
United Kingdom	www.viewsoniceurope.com/ uk/	www.viewsoniceurope.com/ uk/support/call-desk/	service_gb@viewsoniceurope.com
United States	www.viewsonic.com	T (Toll-Free)= 1-800-688-6688 T (Toll)= 1-424-233-2530 F= 1-909-468-3757	service.us@viewsonic.com

# Limited Warranty

## VIEWSONIC Digital Photo Frame

### **What the warranty covers:**

ViewSonic warrants its products to be free from defects in material and workmanship, under normal use, during the warranty period. If a product proves to be defective in material or workmanship during the warranty period, ViewSonic will, at its sole option, repair or replace the product with a like product. Replacement product or parts may include remanufactured or refurbished parts or components.

### **How long the warranty is effective:**

ViewSonic Digital Photo Frame are warranted for 1 year for labor from the date of the first customer purchase.

### **Who the warranty protects:**

This warranty is valid only for the first consumer purchaser.

### **What the warranty does not cover:**

1. Any product on which the serial number has been defaced, modified or removed.
2. Damage, deterioration or malfunction resulting from:
  - a. Accident, misuse, neglect, fire, water, lightning, or other acts of nature, unauthorized product modification, or failure to follow instructions supplied with the product.
  - b. Repair or attempted repair by anyone not authorized by ViewSonic.
  - c. Causes external to the product, such as electric power fluctuations or failure.
  - d. Use of supplies or parts not meeting ViewSonic's specifications.
  - e. Normal wear and tear.
  - f. Any other cause which does not relate to a product defect.
3. Any product exhibiting a condition commonly known as "image burn-in" which results when a static image is displayed on the product for an extended period of time.
4. Removal, installation, one way transportation, insurance, and set-up service charges.

### **How to get service:**

1. For information about receiving service under warranty, contact ViewSonic Customer Support (please refer to Customer Support page). You will need to provide your product's serial number.
2. To obtain warranted service, you will be required to provide (a) the original dated sales slip, (b) your name, (c) your address, (d) a description of the problem, and (e) the serial number of the product.
3. Take or ship the product freight prepaid in the original container to an authorized ViewSonic service center or ViewSonic.
4. For additional information or the name of the nearest ViewSonic service center, contact ViewSonic.

### **Limitation of implied warranties:**

There are no warranties, express or implied, which extend beyond the description contained herein including the implied warranty of merchantability and fitness for a particular purpose.

### **Exclusion of damages:**

ViewSonic's liability is limited to the cost of repair or replacement of the product. ViewSonic shall not be liable for:

1. Damage to other property caused by any defects in the product, damages based upon inconvenience, loss of use of the product, loss of time, loss of profits, loss of business opportunity, loss of goodwill, interference with business relationships, or other commercial loss, even if advised of the possibility of such damages.
2. Any other damages, whether incidental, consequential or otherwise.
3. Any claim against the customer by any other party.
4. Repair or attempted repair by anyone not authorized by ViewSonic.

# Mexico Limited Warranty

## VIEWSONIC Digital Photo Frame

### What the warranty covers:

ViewSonic warrants its products to be free from defects in material and workmanship, under normal use, during the warranty period. If a product proves to be defective in material or workmanship during the warranty period, ViewSonic will, at its sole option, repair or replace the product with a like product. Replacement product or parts may include remanufactured or refurbished parts or components.

### How long the warranty is effective:

ViewSonic Digital Photo Frame are warranted for 1 year for labor from the date of the first customer purchase.

### Who the warranty protects:

This warranty is valid only for the first consumer purchaser.

### What the warranty does not cover:

1. Any product on which the serial number has been defaced, modified or removed.
2. Damage, deterioration or malfunction resulting from:
  - a. Accident, misuse, neglect, fire, water, lightning, or other acts of nature, unauthorized product modification, or failure to follow instructions supplied with the product.
  - b. Repair or attempted repair by anyone not authorized by ViewSonic.
  - c. Causes external to the product, such as electric power fluctuations or failure.
  - d. Use of supplies or parts not meeting ViewSonic's specifications.
  - e. Normal wear and tear.
  - f. Any other cause which does not relate to a product defect.
3. Any product exhibiting a condition commonly known as "image burn-in" which results when a static image is displayed on the product for an extended period of time.

### How to get service:

For information about receiving service under warranty, contact ViewSonic Customer Support (Please refer to the attached Customer Support page). You will need to provide your product's serial number, so please record the product information in the space provided below on your purchase for your future use. Please retain your receipt of proof of purchase to support your warranty claim.

For Your Records

Product Name: \_\_\_\_\_ Model Number: \_\_\_\_\_

Document Number: \_\_\_\_\_

Serial Number: \_\_\_\_\_ Purchase Date: \_\_\_\_\_

Extended Warranty Purchase? \_\_\_\_\_ (Y/N)

If so, what date does warranty expire? \_\_\_\_\_

1. To obtain warranty service, you will be required to provide (a) the original dated sales slip, (b) your name, (c) your address, (d) a description of the problem, and (e) the serial number of the product.
2. Take or ship the product in the original container packaging to an authorized ViewSonic service center.
3. Round trip transportation costs for in-warranty products will be paid by ViewSonic.

**Limitation of implied warranties:**

There are no warranties, express or implied, which extend beyond the description contained herein including the implied warranty of merchantability and fitness for a particular purpose.

**Exclusion of damages:**

ViewSonic's liability is limited to the cost of repair or replacement of the product. ViewSonic shall not be liable for:

1. Damage to other property caused by any defects in the product, damages based upon inconvenience, loss of use of the product, loss of time, loss of profits, loss of business opportunity, loss of goodwill, interference with business relationships, or other commercial loss, even if advised of the possibility of such damages.
2. Any other damages, whether incidental, consequential or otherwise.
3. Any claim against the customer by any other party.
4. Repair or attempted repair by anyone not authorized by ViewSonic.

<b>Contact Information for Sales &amp; Authorized Service (Centro Autorizado de Servicio) within Mexico:</b>	
Name, address, of manufacturer and importers: México, Av. de la Palma #8 Piso 2 Despacho 203, Corporativo Interpalmas, Col. San Fernando Huixquilucan, Estado de México Tel: (55) 3605-1099 <a href="http://www.viewsonic.com/la/soporte/index.htm">http://www.viewsonic.com/la/soporte/index.htm</a>	
<b>NÚMERO GRATIS DE ASISTENCIA TÉCNICA PARA TODO MÉXICO: 001.866.823.2004</b>	
<b>Hermosillo:</b> Distribuciones y Servicios Computacionales SA de CV. Calle Juarez 284 local 2 Col. Bugambilias C.P: 83140 Tel: 01-66-22-14-9005 E-Mail: <a href="mailto:disc2@hmo.megared.net.mx">disc2@hmo.megared.net.mx</a>	<b>Villahermosa:</b> Compumantenimientos Garantizados, S.A. de C.V. AV. GREGORIO MENDEZ #1504 COL, FLORIDA C.P. 86040 Tel: 01 (993) 3 52 00 47 / 3522074 / 3 52 20 09 E-Mail: <a href="mailto:compumantenimientos@prodigy.net.mx">compumantenimientos@prodigy.net.mx</a>
<b>Puebla, Pue. (Matriz):</b> RENTA Y DATOS, S.A. DE C.V. Domicilio: 29 SUR 721 COL. LA PAZ 72160 PUEBLA, PUE. Tel: 01(52).222.891.55.77 CON 10 LINEAS E-Mail: <a href="mailto:datos@puebla.megared.net.mx">datos@puebla.megared.net.mx</a>	<b>Veracruz, Ver.:</b> CONEXION Y DESARROLLO, S.A DE C.V. Av. Americas # 419 ENTRE PINZÓN Y ALVARADO Fracc. Reforma C.P. 91919 Tel: 01-22-91-00-31-67 E-Mail: <a href="mailto:gacosta@qplus.com.mx">gacosta@qplus.com.mx</a>
<b>Chihuahua</b> Soluciones Globales en Computación C. Magisterio # 3321 Col. Magisterial Chihuahua, Chih. Tel: 4136954 E-Mail: <a href="mailto:Cefeo@soluglobales.com">Cefeo@soluglobales.com</a>	<b>Cuernavaca</b> Compusupport de Cuernavaca SA de CV Francisco Leyva # 178 Col. Miguel Hidalgo C.P. 62040, Cuernavaca Morelos Tel: 01 777 3180579 / 01 777 3124014 E-Mail: <a href="mailto:aquevedo@compusupportcva.com">aquevedo@compusupportcva.com</a>
<b>Distrito Federal:</b> QPLUS, S.A. de C.V. Av. Coyoacán 931 Col. Del Valle 03100, México, D.F. Tel: 01(52)55-50-00-27-35 E-Mail : <a href="mailto:gacosta@qplus.com.mx">gacosta@qplus.com.mx</a>	<b>Guadalajara, Jal.:</b> SERVICRECE, S.A. de C.V. Av. Niños Héroes # 2281 Col. Arcos Sur, Sector Juárez 44170, Guadalajara, Jalisco Tel: 01(52)33-36-15-15-43 E-Mail: <a href="mailto:mmiranda@servicrece.com">mmiranda@servicrece.com</a>
<b>Guerrero Acapulco</b> GS Computación (Grupo Sesicomp) Progreso #6-A, Colo Centro 39300 Acapulco, Guerrero Tel: 744-48-32627	<b>Monterrey:</b> Global Product Services Mar Caribe # 1987, Esquina con Golfo Pérsico Fracc. Bernardo Reyes, CP 64280 Monterrey N.L. México Tel: 8129-5103 E-Mail: <a href="mailto:aydeem@gps1.com.mx">aydeem@gps1.com.mx</a>
<b>MÉRIDA:</b> ELECTROSER Av Reforma No. 403Gx39 y 41 Mérida, Yucatán, México CP97000 Tel: (52) 999-925-1916 E-Mail: <a href="mailto:rrrb@sureste.com">rrrb@sureste.com</a>	<b>Oaxaca, Oax.:</b> CENTRO DE DISTRIBUCION Y SERVICIO, S.A. de C.V. Murguía # 708 P.A., Col. Centro, 68000, Oaxaca Tel: 01(52)95-15-15-22-22 Fax: 01(52)95-15-13-67-00 E-Mail: <a href="mailto:gpotai2001@hotmail.com">gpotai2001@hotmail.com</a>
<b>Tijuana:</b> STD Av Ferrocarril Sonora #3780 L-C Col 20 de Noviembre Tijuana, Mexico	<b>FOR USA SUPPORT:</b> ViewSonic Corporation 381 Brea Canyon Road, Walnut, CA. 91789 USA Tel: 800-688-6688 (English); 866-323-8056 (Spanish); Fax: 1-800-685-7276 E-Mail: <a href="http://www.viewsonic.com">http://www.viewsonic.com</a>



**ViewSonic®**